

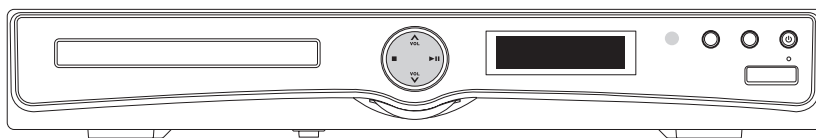

RCA

USER MANUAL

RTB1100



It's important to read this instruction prior to using your new product for the first time.





FCC Information

This device complies with part 15 of the FCC Rules. Operation is subject to the following two conditions: (1) This device may not cause harmful interference, and (2) this device must accept any interference received, including interference that may cause undesired operation.

This equipment has been tested and found to comply with the limits for a Class B digital device, pursuant to part 15 of the FCC Rules. These limits are designed to provide reasonable protection against harmful interference in a residential installation. This equipment generates, uses and can radiate radio frequency energy and, if not installed and used in accordance with the instructions, may cause harmful interference to radio communications.

However, there is no guarantee that interference will not occur in a particular installation. If this equipment does cause harmful interference to radio or television reception, which can be determined by turning the equipment off and on, the user is encouraged to try to correct the interference by one or more of the following measures:

- Reorient or relocate the receiving antenna.
- Increase the separation between the equipment and receiver.
- Connect the equipment into an outlet on a circuit different from that to which the receiver is connected.
- Consult the dealer or an experienced radio / TV technician for help.

WARNING: Changes or modifications to this unit not expressly approved by the party responsible for compliance could void the user's authority to operate the equipment.



This Home Theater has earned the ENERGY STAR.

Ventilation

You must adequately ventilate the product. Make sure there is adequate space around the unit to provide proper air flow for ventilation. See diagram.

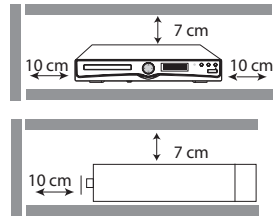

This product complies with DHHS Rules 21 CFR Subchapter J. Applicable at the date of manufacture.

For your Safety

The AC power plug is polarized (one blade is wider than the other) and only fits into AC power outlets one way. If the plug won't go into the outlet completely, turn the plug over and try to insert it the other way.

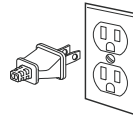

If it still won't fit, contact a qualified electrician to change the outlet, or use a different one. Do not attempt to bypass this safety feature.

Removing the power plug is the only way to completely remove power from your product. Make sure the power plug remains easily accessible.

Note:

This unit has been designed to play back BD-video with region "A" and DVD-video with region "1". You cannot play back BD-video or DVD-video that are labeled for other regions. Look for the symbols on the right on your BD-video or DVD-video. If these region symbols do not appear on your BD-video or DVD-video, you cannot play back the disc in this unit. The letter or number inside the globe refers to region of the world. A BD-video or DVD-video labeled for a specific region can only be played back in the unit with the same region code.





Important Information



SEE MARKING ON BACK OF PRODUCT

THE LIGHTNING FLASH AND ARROWHEAD WITHIN THE TRIANGLE IS A WARNING SIGN ALERTING YOU OF "DANGEROUS VOLTAGE" INSIDE THE PRODUCT.

THE EXCLAMATION POINT WITHIN THE TRIANGLE IS A WARNING SIGN ALERTING YOU OF IMPORTANT INSTRUCTIONS ACCOMPANYING THE PRODUCT.

CAUTION: TO REDUCE THE RISK OF ELECTRIC SHOCK, DO NOT REMOVE COVER (OR BACK). NO USER SERVICEABLE PARTS INSIDE. REFER SERVICING TO QUALIFIED SERVICE PERSONNEL.

WARNING: TO PREVENT FIRE OR ELECTRICAL SHOCK HAZARD, DO NOT EXPOSE THIS PRODUCT TO RAIN OR MOISTURE.

CAUTION: USE OF CONTROLS OR ADJUSTMENTS OR PERFORMANCE OF PROCEDURES OTHER THAN THOSE SPECIFIED MAY RESULT IN HAZARDOUS RADIATION EXPOSURE.

CAUTION: DANGER OF EXPLOSION IF BATTERY IS INCORRECTLY REPLACED. REPLACE ONLY WITH THE SAME OR EQUIVALENT TYPE.

WARNING: TO BE COMPLETELY DISCONNECT THE POWER INPUT, THE MAINS PLUG OF APPARATUS SHALL BE DISCONNECTED FROM THE MAINS. THE MAINS PLUG OF APPARATUS SHOULD NOT BE OBSTRUCTED OR SHOULD BE EASILY ACCESSED DURING INTENDED USE.

Service Information

This product should be serviced only by those specially trained in appropriate servicing techniques.

Main plug is used as the disconnect device, it shall remain operable and should not be obstructed during intended use. To be completely disconnected the apparatus from supply mains, the main plug of the apparatus shall be disconnected from the mains socket outlet completely.

Caution

Invisible laser radiation when open and interlocks defeated. Avoid exposure to beam. Class 1 laser product.

This system must be opened only by qualified technicians to prevent accidents caused by the laser beam.

DVD Copy Protection

In accordance with the DVD standard, your DVD player is equipped with a Copy Protection system, which can be switched on and off by the DVD disc itself, in order to make any recording of the relevant DVD disc onto a videotape of very poor picture quality, or even impossible. This product incorporates copyright protection technology that is protected by method claims of certain U.S. patents and other intellectual property rights owned by Macrovision Corporation and other rights owners. Use of this copyright protection technology must be authorized by Macrovision Corporation, and is intended for home use only unless otherwise authorized by Macrovision Corporation. Reverse engineering or disassembly is prohibited.





Important Information

Important Battery Information

- Do not mix different types of batteries or new and old batteries. Do not use rechargeable batteries.
- In order to avoid any risk of explosion, observe the polarities indicated inside the battery compartment. Replace only with the type of batteries specified. Do not dispose of them in a fire or recharge them.
- If you are not using the remote control for a long period of time, remove the batteries.

Please respect the environment and prevailing regulations. Before you dispose of batteries or accumulators, ask your dealer whether they are subject to special recycling and if they will accept them for disposal.



Illustrations contained in this document are for representation only.

CLASS 1 LASER PRODUCT
APPAREIL À LASER DE CLASSE 1
PRODUCTO LASER DE CLASE 1

CAUTION:

This product utilizes a laser. Use of controls or adjustments or performance of procedures other than those specified may result in hazardous radiation exposure. Do not open covers and do not repair yourself. Refer servicing to qualified personnel.

This Class B digital apparatus complies with Canadian ICES-003.

Cet appareil numérique de la classe B est conforme à la norme du NMB-003 du Canada.

WARNING

To reduce the risk of fire or electric shock, do not expose this product to rain or moisture. No objects filled with liquids, such as vases, should be placed on the apparatus.



Double insulation when servicing use only identical replacement parts.



This product contains a low power laser device.



Important Safety Instructions

Please Read and Save for Future Reference.

Some of the following information may not apply to your particular product; however, as with any electronic product, precautions should be observed during handling and use.

- Read these instructions.
- Keep these instructions.
- Heed all warnings.
- Follow all instructions.
- Do not use this apparatus near water.
- Clean only with a dry cloth.
- Do not block any ventilation openings. Install in accordance with the manufacturer's instructions.
- Do not install near any heat sources such as radiators, heat registers, stoves, or other apparatus (including amplifiers) that produce heat.
- Only use attachments / accessories specified by the manufacturer.
- Do not defeat the safety purpose of the polarized or grounding-type plug. A polarized plug has two blades with one wider than the other. A grounding type plug has two blades and a third grounding prong. The wide blade or the third prong is provided for your safety. If the provided plug does not fit into your wall outlet, consult an electrician for replacement of the obsolete outlet.
- Protect the power cord from being walked on or pinched particularly at plugs, convenience receptacles, and the point where they exit from the apparatus.
- Unplug this apparatus during lightning storms or when unused for long periods of time.
- Use only with a cart, stand, tripod, bracket, or table specified by the manufacturer, or sold with the apparatus. When a cart is used, use caution when moving the cart/apparatus combination to avoid injury from tip-over.
- Refer all servicing to qualified service personnel. Servicing is required when the apparatus has been damaged in any way, such as the power cord or plug is damaged, liquid has been spilled or objects have fallen into the apparatus, the apparatus has been exposed to rain or moisture, does not operate normally, or has been dropped.



Portable Cart
Warning

Additional Safety Information

- The apparatus shall not be exposed to dripping or splashing and that no objects filled with liquids, such as vases, shall be placed on the apparatus.
- Always leave sufficient space around the product for ventilation. Do not place product in or on a bed, rug, in a bookcase or cabinet that may prevent air flow through vent openings.
- Do not place lighted candles, cigarettes, cigars, etc. on the product.
- Connect power cord only to AC power source as marked on the product.
- Care should be taken so that objects do not fall into the product.
- Do not attempt to disassemble the cabinet. This product does not contain customer serviceable components.

If your product operates on batteries, adhere to the following precautions:

- A. Any battery may leak electrolyte if mixed with a different battery type, if inserted incorrectly, or if all batteries are not replaced at the same time.
- B. Any battery may leak electrolyte or explode if disposed of in fire or an attempt is made to charge a battery not intended to be recharged.
- C. Discard leaky batteries immediately. Leaking batteries can cause skin burns or other personal injury. When discarding batteries, be sure to dispose of them in the proper manner, according to your state/provincial and local regulations.
- D. Battery shall not be exposed to excessive heat such as sunshine, fire or the like.



Features

- Full high-definition video playback at up to 1080p resolution for an amazing viewing experience. Upconversion of standard definition DVDs for enhanced picture quality at up to 1080p over an HDMI connection.
- Rich multi-channel surround sound.
- Easy and simple HDTV connection using a single HDMI cable (cable not included).
- Multiple outputs for connecting your home theater system or amplifier.
- PIP functionality that lets you display primary and secondary video at the same time (if available on the Blu-ray Disc).
- Pop-up menu display without interrupting playback (if available on the Blu-ray Disc).
- HDMI 1080p/60fps output (Blu-ray Disc only) that provides smooth playback of video with a frame rate of 60 frames per second (TV must be connected with an HDMI cable and be compatible with 1080p 60 frame).

Connections and Setup

Accessories Provided

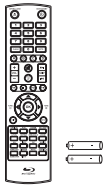

Remote control and 2
AAA batteries

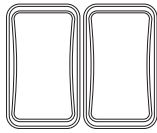

Left and right front
speakers

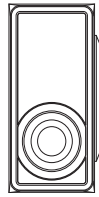

Subwoofer

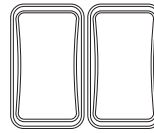

Left and right Sur-
round speakers

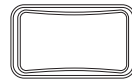

Center speaker



One Pig-Tail
antenna wire



Composite
video cable



One external AM
loop antenna





Connections and Setup

Things to Consider before You Connect

- Ensure that the mains supply in your house complies with that indicated on the identification sticker located on the back of your unit.
- Install your unit horizontally, away from any source of heat (fireplace) or appliances creating strong magnetic or electric fields. The components of this unit are sensitive to heat. The maximum ambient temperature should not exceed 35°C / 95°F.
- Leave enough space around the unit to allow adequate ventilation: 10 cm/4 inches on either side and above the top, and 5 cm/2 inches at the rear.
- The humidity of the room should not exceed 75%. If you have to use the unit outdoors, do not expose it to rain or splashing water. The apparatus should not be exposed to dripping or splashing and no objects filled with liquids, such as vases, should be placed on the apparatus.
- Moving the unit from a cold place to a warm one can cause condensation on some components inside the unit. Let the condensation disappear on its own before turning the unit on again.
- Before moving the unit, make sure the disc tray is empty.
- Where the mains plug or an appliance coupler is used as a disconnect device, the disconnect device shall remain readily operable.
- Other important use and cleaning information at the end of the booklet.

Connecting the Antennas

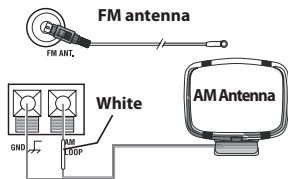

The AM and FM antennas connect to the AM and FM terminals on the system's back panel. They must be hooked up in order to receive clear reception.

AM Loop Antenna

1. Uncoil the AM antenna wire.
2. Press down on the antennas tab to open the terminal.
3. Make sure the white wire on the AM loop antenna is inserted into the AM loop terminal and the other wire is inserted into the ground loop terminal.

Connecting to Your TV (VIDEO)

Method 2

Method 1

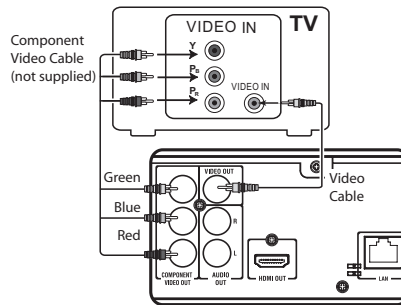

Method 1

Composite video jack (yellow)

- The basic video jack is color-coded yellow.
- Video cable (yellow) is supplied for the connection for good picture quality.
- Connect the video OUT jack on the receiver to the Video IN jack on your TV so the video content goes from the receiver to the screen.

Method 2

Component video jacks (Pr, Pb, Y)

- The component video jacks are color-coded green, blue and red.
- Additional component video cables (not supplied) are required to provide better picture quality. They are usually color-coded green, blue and red.
- Connect the component video OUT jacks on the receiver to the component video IN jacks on your TV so the video content goes from the receiver to the screen.





Connections and Setup



- If your television is a high definition television, use the unit's HDMI output to get the highest possible video resolution.
- If one of the devices is not working, check that all the cables have been inserted properly into the jacks.
- If your component has only one input for audio (mono), connect it to the left (white L/Mono) audio jack on the TV and don't connect the right audio part of the cable.

Connecting to Your TV (via HDMI input)

HDMI stands for High Definition Multimedia Interface. HDMI transfers digital audio and uncompressed digital video on a single cable. You can select the resolution of the player's HDMI output to match your TV's resolution capabilities, please see instructions on page 18 for **Resolution** setting.

Connecting AUDIO OUT to an Audio System (via 2-Channel Analog Audio Output)

Connect the AUDIO OUT jacks from the unit to the AUDIO IN jacks on TV, VCR, Stereo system or other audio component.

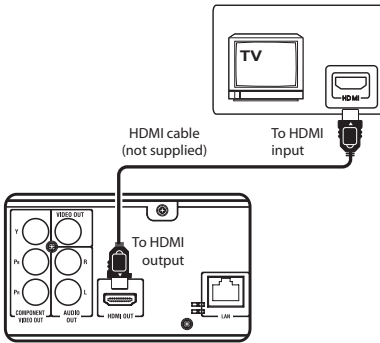
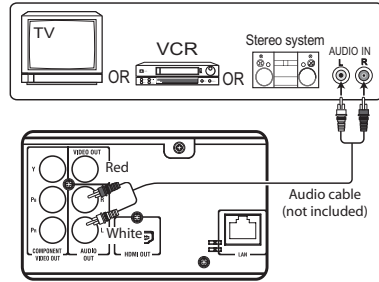

Note:
Refer to the owner's manual of the connected TV as well.





Connections and Setup

Connecting AUDIO IN from External Sources such as TV

Using AUDIO IN Jacks

Connect the AUDIO IN jacks from the unit to the AUDIO OUT jacks on VCR, TV, SAT/Cable Box or other component. Press either **SOURCE** button on the main unit or **AUX** button on the remote control to select **AUX** mode.

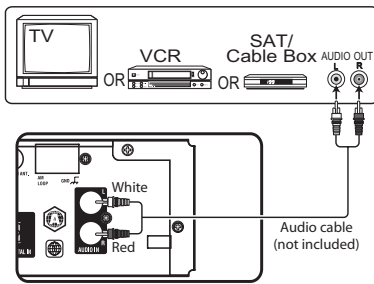

Connecting your player to a wired router

Connect an Ethernet cable (CAT5 or better with RJ45 connector) to the ETHERNET jack on the back of your player and to an Ethernet jack on a hub or broadband router.

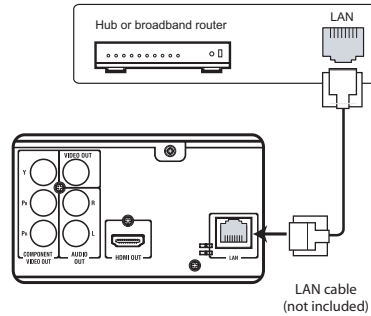

Digital Optical Input

Connect components capable of outputting Dolby digital (e.g. TV or SAT/Cable Box) or standard PCM (CD) format digital signals. Use a fiber optical cable for this digital audio connection. (Cable not included).

Press **OPTICAL** button on remote control or **SOURCE** button on main unit to select **OPTICAL** for digital audio output components.

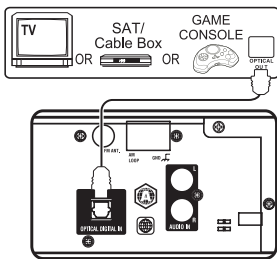

Notes:

- Do not connect a modular phone cable to the ETHERNET jack.
- When plugging or unplugging the cable, hold the connector on the end of the cable. When unplugging, do not pull on the cable. Press down the lock tab and pull the connector out of the jack.
- Because there are various connection configurations, follow the instructions from your telecommunication carrier or Internet service provider.



Connections and Setup

Connecting the Speakers

Speaker wires are color-coded to match the terminals. Connect the speaker wire from the back of each speaker to the corresponding color terminal at the back of the unit. Press down the tab to open the terminal and insert the wire. Release the tab to lock wire in the terminal.

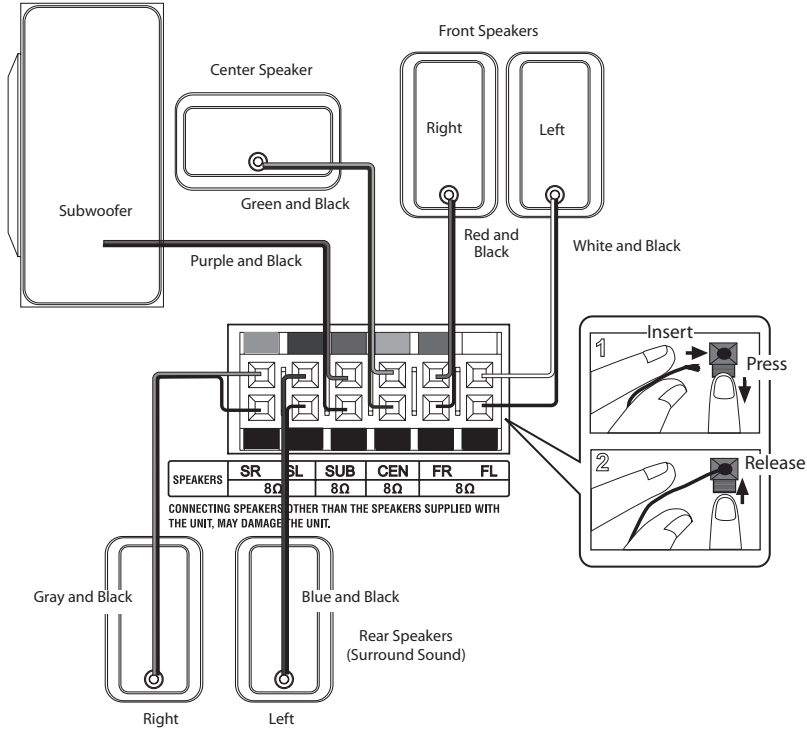

To adjust each speaker volume level for optimum listening experience.

- (1) Press the **LEVEL** button on the remote control to select FL (front Left speaker).
- (2) Press the **▲** or **▼** buttons to adjust the value up or down (between -10dB and +10dB).
- (3) Repeat step (1) and (2) for the other speakers FR, SL, SR, CT, SW.

Speaker gains may be set to levels of up to +10dB, actual max levels may also depend on your Volume Setting.



Note:

When connecting the speakers, make sure the polarities (“+” speaker wire to “+” on the receiver) of speaker wires and terminals match. For example, red wire to red terminal on the receiver. If the cords are reversed, the sound will be distorted. Do not let the speaker wires touch each other, it will damage the system’s amplifier.





Connections and Setup

Positioning Speakers

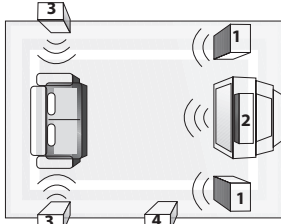

Courtesy Dolby Laboratories

1. Left, Right (Front Speakers)

Front speakers carry primarily music and sound effects.

2. Center

In surround mode, the center speaker carries most of the dialog as well as music and effects. It should be set between the left and right speakers.

3. Surround (Rear Speakers)

The surround speakers' overall sound balance should be as close as possible to the front speakers. Proper placement is vital to establish an evenly distributed sound field.

4. Subwoofer

A subwoofer is designed to reproduce powerful low bass effects (explosions, the rumble of spaceships, etc.).



Note:

Center speaker provided with this unit is magnetically shielded to protect your TV set. It is not recommended to place speakers without magnetic shield near the TV set.

Front Speaker Placement

For best results, follow the speaker placement below.

Alignment

Align the center speaker evenly with (A) or slightly behind (B) (the left and right speakers), but not ahead of them.

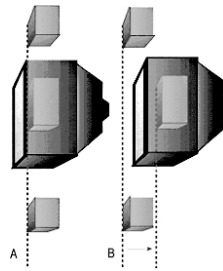

Angle

Place the left and right speakers to form a 45-degree angle with your favorite viewing position to duplicate the soundtrack mixer's perspective.

Height

The three front speakers should be as close as possible to the same height. This often requires placing the center speaker directly on top (A) or beneath (B) the TV set.

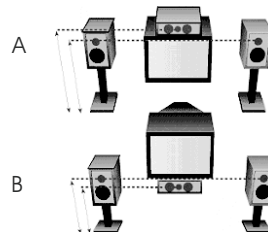



Connections and Setup

Better Surround Placement

Location

If possible, place surround speakers to either side of the listening area, not behind it.

Height

If space permits, install surround speakers 2-3 feet above viewers. This helps to minimize localization effects.

Aiming

Aim surround speakers straight across the room, not down at viewers, to help create a more open, spacious surround sound field.

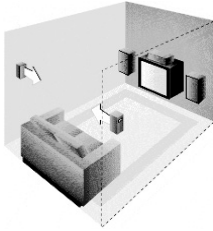

No adjacent walls

Surround speakers can go on stands facing each other to approximate sidewall mounting (A), or to the sides or rear of the viewing area, aimed upwards; they can go right on the floor, or preferably, a few feet off the floor such as on end tables (B).

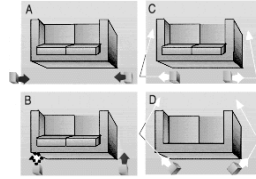

Test Tone/Channel Balance

Channel Balance

Your receiver is equipped with a test signal generator to help balance the audio level for each channel. See Audio Setup under The Setup Menu section for more details on how to access this feature.

Level Adjustment and Surround Channel Level Expectation

Even though you adjust the surround channel to be as loud as the others on the test signal, you may find that surround channels seems quieter for actual TV and Movie content. This is because producers use surround for subtle atmospheric and ambience, and only rarely for special effects.

Alternative Surround Placement

Rear wall

If rear wall mounting is the only choice, aim the speakers at each other (A), towards the front (B) or towards the sidewalls (C, D).

Experiment with placement until sounds seem to surround you, rather than come from behind you.

Overview of Controls - Front Panel Controls

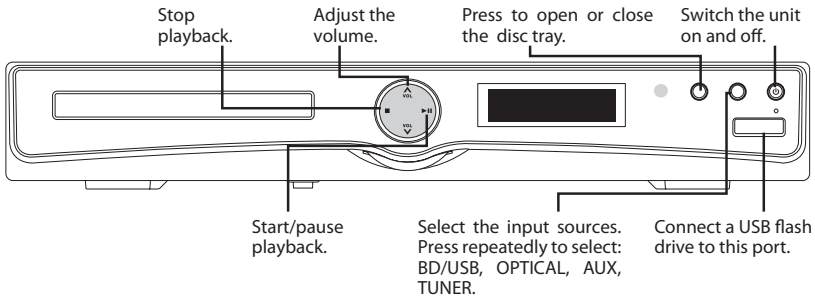

Overview of Controls

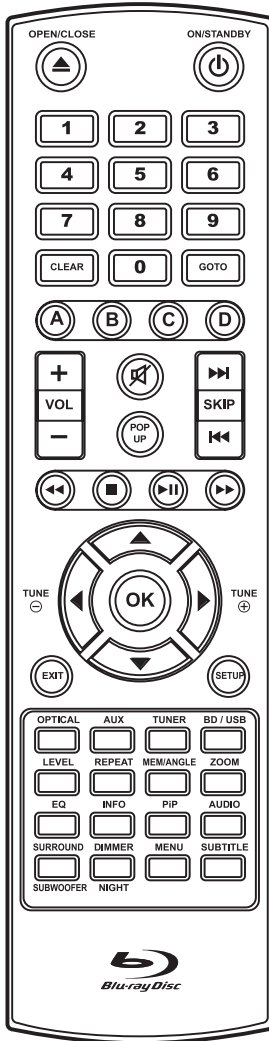

- OPEN/CLOSE** Press to open or close the disc tray.
- ON/STANDBY** Press to turn on your unit, or put your unit in standby mode. When your unit is in standby mode, power is still entering your unit. To disconnect power, unplug the power cord.
- Numbers** In playback mode, press **GOTO** button, then press the number buttons to enter a title, chapter, track, or time.
- CLEAR** Press to clear an input.
- GOTO** Press to search for a title, chapter, track or time.
- A (red), B (green), C (yellow), D (blue)** When playing a Blu-ray Disc that has a Java application, press to control playback. For more information, see the documentation that came with the Blu-ray Disc.
- VOL +/-** Press to increase or decrease the volume.
- MUTE** Press to turn off sound. Press again to turn the sound back on.
- POP UP** During Blu-ray Disc playback, press to open a menu that lets you control Blu-ray Disc playback. During DVD playback, press to open the DVD title menu (if available).
- SKIP ►► / ◄◄** Press to go to the next or previous chapter (Blu-ray Disc/DVD) or track (CD). In tuner mode, press to go to the next higher /lower preset station.
- REV** Press to fast reverse.
- STOP** Press to stop playback.
- PLAY/PAUSE** Press to start or pause playback.
- FWD** Press to fast forward.
- ▲, ◀TUNE ⊖, ▶TUNE ⊕, ▼** Navigate through the menus. The left and right arrows also tune the radio frequency in the tuner mode.
- OK** Confirms your selection.
- EXIT** Press to return to the previous menu.
- SETUP** Press to access the speaker setting and test tone. To enable or disable the Center speaker/surround speakers, press this button, and press ◀▶ buttons to select Center Speaker or Surround Speaker, then use ▲/▼ buttons on the remote control to choose **YES** or **NO**.
To start or end the test tone, press this button, and press ◀▶ buttons to select **TS TONE**, then press **OK** button. The audio signal will be sent to a different speaker every approximately two seconds; you can also use ◀▶ buttons to select the speaker channel you wish to test and adjust, you'll hear a test tone coming from the speaker you select, use ▲/▼ buttons to adjust the level to your desired setting. Press **OK** button to exit this function.
- OPTICAL** Press to select OPTICAL input source.
- AUX** Press to select AUX input source.
- TUNER** Press to select TUNER mode, and toggle between the FM and AM bands.

Overview of Controls

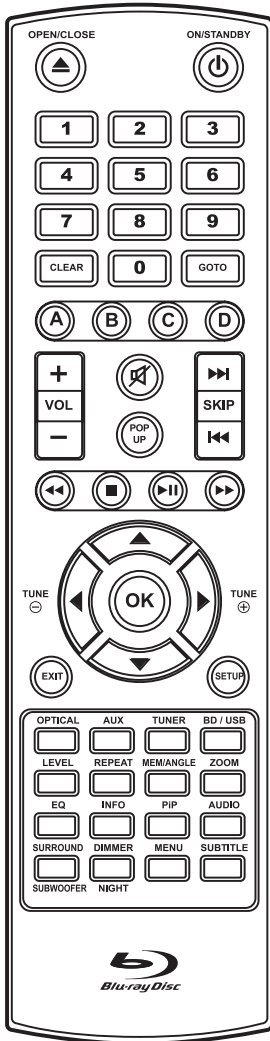

BD/USB	Press to select the BD/USB mode.
LEVEL	Toggle channels for different level settings. Adjusts the value using ▲/▼.
REPEAT	Press to repeat the current title, chapter, track, or repeat all. This button is only used for DVD/CD discs.
MEM/ANGLE	Stores a station in tuner mode. Accesses the camera angle function for Blu-ray or DVD discs if available.
ZOOM	Press to zoom in on the video. Each time you press this button, the magnification level changes. This button is only used for DVD discs.
EQ	Selects among preset equalizer mode (POP, ROCK, CLASSIC, JAZZ, BASS, TREBLE and FLAT). Press the corresponding button to select the desired sound mode. This function is only available in Stereo mode. Note: For BASS and TREBLE effects, you can use ▲/▼ buttons on the remote control to adjust the value up or down by step 2 dB (between -10dB and +10dB).
INFO	Accesses the Info menu.
PIP	Press to turn PIP (picture in picture) mode on or off. This function is only available by Blu-ray discs if available on disc.
AUDIO	Accesses the audio function. PiP Audio can be selected through cursor if secondary Audio is available on the Blu-ray Disc. Selects between Stereo and Mono mode for Tuner (FM).
SURROUND/ SUBWOOFER	Press repeatedly to display current Surround Sound setting or display current Subwoofer setting (Soft/Balance/Strong/Powerful). To change settings, first press repeatedly to access the current Surround or Subwoofer setting, then use ▲/▼ buttons on the remote control to change the current setting.
DIMMER/ NIGHT	Press repeatedly to show the display window brightness level or the current NIGHT mode, then use ▲/▼ buttons on the remote control to change the current setting. Note: NIGHT mode is only available for set and effective during Dolby Digital signal playback.
MENU	Accesses the disc menu during playback.
SUBTITLE	Accesses the subtitle function. PiP Subtitle can be selected through cursor if secondary subtitle is available on the Blu-ray Disc.



Note:
Insert the two "AAA" (included with this unit) batteries into the remote control prior to use.



Basic Playback Operations

Compatible Discs

- Blu-ray Disc
- DVD-video (DVD-ROM)
- DVD+RW, DVD-RW
- DVD+/-R
- Audio CDs (CDDA)
- JPEG

Regional Coding

This unit has been designed to play back BD-video with region "A" and DVD-video with region "1". You cannot play back BD-video or DVD-video that are labeled for other regions. Look for the symbols on the right on your BD-video or DVD-video.

If these region symbols do not appear on your BD-video or DVD-video, you cannot play back the disc in this unit. The letter or number inside the globe refers to region of the world. A BD-video or DVD-video labeled for a specific region can only be played back in the unit with the same region code.

Playing a Blu-ray Disc or DVD

1. Turn on your television set.
2. Press **ON/STANDBY** button on the remote control or **STANDBY/ON** button located on the unit's front panel. Press **BD/USB** on the remote control.
3. Press **▲ OPEN/CLOSE** button to open the disc tray.
4. Place a disc onto the disc tray with the label side up.
5. Press **▲ OPEN/CLOSE** button again to close the disc tray.
6. After loading a disc, playback starts automatically, or the disc menu appears. If the disc menu appears, select the Play option to begin playback.

Controlling Blu-ray Disc or DVD Playback

- To start or pause playback, press **▶II** button. The sound is muted when your unit is in pause mode. To resume normal playback, press **▶II** button.
- To stop playback, press **■** button. The **Settings** menu is displayed. To resume playback, press **▲** or **▼** button to select DVD/BD-ROM, then press **OK** button. Depending on the disc, playback starts where it stopped or at the beginning of the disc. If you press **■** button twice,

playback stops completely. Press **▶II** button to start playback again at the beginning of the disc.

- To fast forward or fast reverse, press **▶▶** (fast forward) or **◀◀** (fast reverse). Each time you press one of these buttons, the fast-forward or fast-reverse speed increases from Fast X2, Fast X4, Fast X8, Fast X16, Fast X32, Fast X64, to Fast X128. Press **▶II** to resume normal playback.
- Press either the **◀◀** or **▶▶** button according to the desired direction. Press the **◀◀◀** button to skip to the start of the current chapter or skip to previous chapters. Press the **▶▶▶** button to skip to the beginning of the next chapter.

Playing files on a data disc or USB thumb drive

When you insert a data disc or USB thumb drive containing picture or video files into your unit, icons are added to the menu to indicate that video or picture files are available for playback.

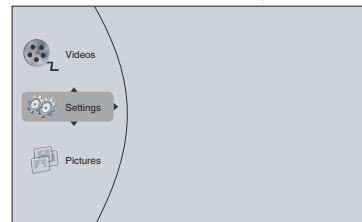

To play video files:

1. Press **▲** or **▼** button to select **Videos**, then press **OK** button. A menu opens.
2. Press **◀** button, and press **▲** or **▼** buttons to select **Play Files**, then press **OK** button. A dialogue window appears.





Basic Playback Operations

- Press **▲** or **▼** button to select **Play All** (plays all files), then press **OK** button to start playback.
 - If you want to see information about the file that is playing, press **INFO** button on the remote control.

To create a playlist:

- Insert a disc or plug in a USB flash drive, select **Videos**, then press **▶** button.
- Press **▲** or **▼** button to select **Optical Disc** or **USB**, then press **OK** button. A file browser window opens with a list of files and folders.
- Press **▲** or **▼** button to select a file or folder, then press **OK** button. If you selected a folder, the files in the folder are displayed. Press **▲** or **▼** button to select a file, then press **OK** button. The following menu opens:

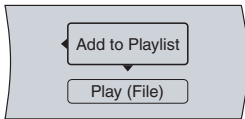

- Press **▲** or **▼** button to select **Add to Playlist**, then press **OK** button. The file is added to the playlist now.



Notes:

- If the file you selected is already in the playlist, **Remove from playlist** appears. When you add a file to the playlist, **Remove all from playlist** appears on the screen automatically. You can use **Remove all from playlist**, **Previous Folder** and **Play Files** to control playback.
- Press **EXIT** button in the file browser window can return to the upper folder.

Viewing photographs

This unit can display digital photographs files that have been stored on to a data disc or USB flash drive.

- Insert a disc or USB flash drive with photograph. The following menu opens:

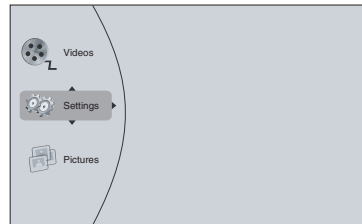

- Press **▲** or **▼** button to select **Pictures**, then press **OK** button.
- Press **◀** button.
- Press **▲** or **▼** button to select an option, then press **OK** button. You can select:
 - Main Menu** - Returns to the main menu.
 - Play Files** - Press **▲** or **▼** button to select an option, then press **OK** button.

To create a playlist:

- Insert a disc or plug in a USB flash drive, select **Pictures**, then press **▶** button.
- Press **▲** or **▼** button to select **Optical Disc** or **USB**, then press **OK** button. A file browser window opens with a list of files and folders.
- Press **◀** button.
- Press **▲** or **▼** button to select an option, then press **OK** button. You can select:
 - Add all to playlist** - Adds all files to the playlist.
 - Previous folder** - returns the previous menu.
 - Play Files** - Plays all files or plays files in the current folder.

To add a JPEG file to the playlist:

- Insert a disc or plug in a USB flash drive, select **Pictures**, then press **▶** button.
- Press **▲** or **▼** button to select **Optical Disc** or **USB**, then press **OK** button.



Basic Playback Operations

- Press **◀▶**, **▲** or **▼** buttons to select a file or folder, then press **OK** button. If you selected a folder, the files in the folder are displayed. Press **◀▶**, **▲** or **▼** buttons to select a file, then press **OK** button. The following menu appears:

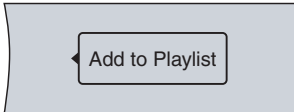

- Press **OK** button again to add the selected file to the playlist.

Playing an audio CD

- Press **ON/STANDBY** button on the remote control or **STANDBY/ON** button located on the unit's front panel.
- Press **▲ OPEN/CLOSE** button to open the disc tray.
- Place a CD on the disc tray with the label facing up, then press **▲ OPEN/CLOSE** button to close the disc tray. It may take a few seconds for the CD to load.
- After loading a disc, playback starts automatically.
- To eject the CD, press **▲ OPEN/CLOSE** button.

To control audio CD playback:

- To start or pause playback, press **▶II** button. The sound is muted when your unit is in pause mode. To resume normal playback, press **▶II** button.
- To stop playback completely, press **■** button. To start playback again, press **▶II** button. Playback starts at the beginning of the CD.
- To fast-forward, press **▶▶** button. To resume normal playback, press **▶II** button.
- To fast-reverse, press **◀◀** button. To resume normal playback, press **▶II** button.
- Press either the **◀◀** or **▶▶** button according to the desired direction. Press the **◀◀** button to skip to the start of the current track or skip to previous tracks. Press the **▶▶** button to skip to the beginning of the next track.
- To select a track, press **GOTO** button once, enter the track number with the number buttons, then press **OK** button. Press **GOTO** button twice to select a desired time position by pressing the appropriate number buttons and **OK** button.

Displaying Blu-ray Disc information

- Press **INFO** button, your unit displays information about the Disc, such as type of disc, current elapsed time in title, total number of chapters.
- Press **INFO** button again to exit.



Note: The information displayed for discs other than Blu-ray Discs will be different.

Searching for a title, chapter, or elapsed time

- During playback, press **GOTO** button one or more times to select a search mode.
 - One press selects **Goto Title** mode.
 - Two presses selects **Goto Chapter** mode.
 - Three presses selects **Goto Time** mode.
- Press the number buttons to enter the title number, chapter number, or time, then press **OK** button. Your unit goes to the title, chapter, or time you entered.

Repeating a title, chapter, or CD track (DVD/CD)

- Press **REPEAT** button one or more times to select a repeat mode.

Using PiP (picture-in-picture) mode

Some Blu-ray Discs are compatible with picture-in-picture (PiP) mode. In PiP mode, the primary video is displayed on the full screen, and the secondary video is displayed in a small window.

Primary video

Secondary video



- Press **PIP** button to turn PiP mode on or off.
- Press **AUDIO** or **SUBTITLE** button to turn the audio/subtitle for the video in the PiP window on or off. Then use cursor buttons and **OK** button to select your preferred options.

Notes:

- The available options of Audio vary from different disc format.
- PiP Subtitle is not available for all discs. It only applies to Blu-ray discs that supports picture-in-picture features.





Basic Playback Operations

Using a disc popup menu

1. During Blu-ray or DVD playback, press **POP UP** button. The Blu-ray popup menu or the title menu of DVD disc opens.
2. Press **▲**, **▼**, **◀** or **▶** buttons to select an option, then press **OK** button.

Selecting a play source

- Press **SOURCE** button on the front panel of the unit repeatedly to select **BD/USB**, **OPTICAL**, **AUX**, **TUNER**.
- Press **BD/USB** button on the remote control to select **BD/USB** mode.
- Press **OPTICAL** button on the remote control to select **OPTICAL** mode.
- Press **AUX** button on the remote control to select **AUX** mode.
- Press **TUNER** button on the remote control to select **TUNER** mode.

Selecting the audio mode

1. Press **AUDIO** button. Your unit displays audio channel information, such as **01/03 Eng Dolby Digital**. **01** indicates the currently selected audio channel. **03** indicates the total number of audio channels. **Eng** (English) indicates the audio language. **Dolby Digital** describes the currently selected audio format.
2. Press **▶** button and press **▲** or **▼** button to select an audio mode, then press **OK** button.

Selecting the camera angle (Blu-ray Disc and DVD disc)

Some discs offer different camera angles for specific scenes. To change the camera angle:

1. Press **MEM/ANGLE** button on the remote control. The selected angle will be displayed on the display bar at the top of the TV screen.
2. Press **▶** button and press **▲** or **▼** button to select the desired angle, then press **OK** button. If the disc was recorded using a single camera angle, this function is not available.

IMPORTANT!

Many BD-Live compatible discs require content to be downloaded onto USB flash drive in order to access the available BD-Live features. A USB flash drive with free space > 1GB needs to be inserted prior to inserting the BD-Live compatible disc.

The Setup Menu

The Settings menu appears automatically when the unit is in BD/USB stop mode.

Language Setting

1. In the main menu of **Settings**, press **▶** button, then use **▲** or **▼** button to select **Language**.

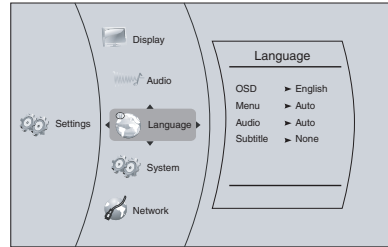

2. Press **▶** button and press **▲** or **▼** button to select an option, then press **OK** button.
3. Press **▲** or **▼** button to select the language you wish, then press **OK** button to confirm your selection.
4. Press **◀** or **EXIT** button to go to the previous menu.



Notes

- If the selected language is not available on a disc, the disc's language will be used instead.
- If the language chosen is available, it is automatically selected when you display the subtitles or press **SUBTITLE** button on the remote control. Otherwise, the subtitle language indicated on the disc is selected.



The Setup Menu

Display Setting

1. In the main menu of **Settings**, press **▶** button, then use **▲** or **▼** button to select **Display**.

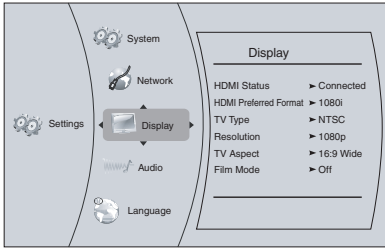

2. Press **▶** button and press **▲** or **▼** button to select an option, then press **OK** button.
3. Press **▲** or **▼** button to select the desired option, and then press **OK** button to confirm your selection.
4. Press **◀** or **EXIT** button to go to the previous menu.

HDMI Status

This option displays the HDMI status. If an HDMI TV is connected, Connected appears. If an HDMI TV is not connected, Disconnected appears.

HDMI Preferred Format

This option shows the best HDMI format for the connected TV.

Resolution

You can define the video output resolution in this option.

HDMI Auto: If your TV is a high-definition TV (HDTV) connected to the HDMI jack on your player and you want your player to set the output resolution based on information exchanged between the TV and your player over the HDMI cable.

1080p: If the TV is a high-definition TV (HDTV) capable of 1080p (any frame rate) connected to the HDMI jack on your player.

1080i: If your TV is a high-definition TV (HDTV) capable of 1080i only.

720p: If your TV is a high-definition TV (HDTV) capable of 720p only.

480p: If your TV is an enhanced-definition TV (EDTV).

480i: If your TV is a standard-definition NTSC TV (American or Asian SD TV).



Notes:

- Selecting a resolution the TV does not support could result in an unstable picture or loss of the picture. See the documentation that came with the TV to find the resolutions the TV supports.
- Only the HDMI output on your unit supports 1080p video output at any frame rate. If the TV is connected to the component output, the video output is limited to 1080i or lower.

TV Aspect

16:9 wide, 16:9 Pillarbox, 4:3 Pan and Scan, and 4:3 Letter Box are available for your choice.

Film Mode

Movies are recorded on film at a rate of 24 pictures (frames) per second. Many of the movies on Blu-ray discs are recorded on the discs at this frame rate. However, not all TVs can display 24 progressive frames/second of video. If the TV cannot display this frame rate, you need to turn off **Film Mode**.



Note:

Only your unit's HDMI output supports 1080p video output at any frame rate. The component outputs are limited to 1080i, regardless of the **Film Mode** setting.





The Setup Menu

Audio Setting

1. In the main menu of **Settings**, press **▶** button, then use **▲** or **▼** button to select **Audio**.

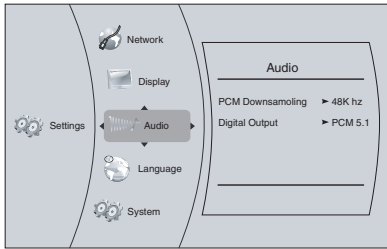

2. Press **▶** button and press **▲** or **▼** button to select an option, then press **OK** button.
3. Press **▲** or **▼** button to select the desired option, and then press **OK** button to confirm your selection.
4. Press **◀** or **EXIT** button to go to the previous menu.

PCM Downsampling

If your player is connected to an audio receiver or TV with an optical cable, you will need to select the highest PCM sampling rate the amplifier supports.

If you **DO NOT** have a surround sound receiver connected to your player through one of the digital audio jacks (optical), select 48kHz. Otherwise, select the highest sampling rate the receiver supports. See the documentation that came with the receiver.

There are 3 options (**48kHz**, **96kHz** and **Off**) are available.



Note:

Setting the optical audio output's PCM downsampling sampling rate too high may result in unpredictable audio playback. If you are not sure, set the rate to 48kHz.

Digital Output

- **PCM 5.1** — Sends a PCM audio signal of up to 5.1 channels over the HDMI connection and up to 2 channels over the optical connection.
- **PCM Stereo** — Sets the output to PCM Stereo if you have not an audio receiver connected to your Blu-ray Disc player or the audio receiver connected to Blu-ray Disc player is not a 5.1 channel receiver.
- **Bitstream HD** — Sends the original bitstream from the disc over the HDMI and SPDIF connections using highest quality possible. HDMI has the higher quality capabilities with advanced audio CODECs like TrueHD and DTS-HD. Blu-ray audio is limited to the soundtrack for the main movie (No PIP audio and no effects audio).
- **Bitstream Legacy** — Sends the original bitstream from the disc over the HDMI and SPDIF connections using legacy audio formats. Blu-ray audio is limited to the soundtrack for the main movie (No PIP audio and no effects audio).
- **Bitstream Mixed** — Sends mixed and encoded Blu-ray audio streams in a single bitstream. This mode is primarily intended for use with SPDIF 5.1CH receivers to produce mixed Blu-ray audio in surround sound.



The Setup Menu

System Setting

1. In the main menu of **Settings**, press **▶** button, then use **▲** or **▼** button to select **System**.

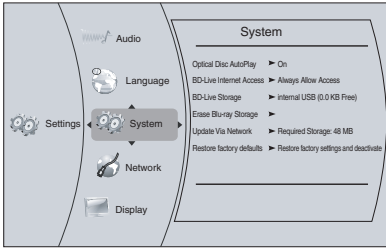

2. Press **▶** button and press **▲** or **▼** button to select an option, then press **OK** button.
3. Press **▲** or **▼** buttons to select the desired option, and then press **OK** button to confirm your selection.
4. Press **◀** or **EXIT** button to go to the previous menu.

Optical Disc AutoPlay

If **On** is selected, it will load data and play back automatically when you insert a Blu-ray disc. When **Off** is selected and if you insert a Blu-ray disc, the disc you can select will be displayed on the Settings menu.

BD-Live Internet Access

- **Limit Access** — Allows Internet access with valid "BDLive" network access approval.
- **Always Allow Access** — Always allows BD-Live Internet access.
- **Prohibit Access** — Never allows BD-Live Internet access.

BD-Live Storage

The available storage space is displayed next to BD-Live Storage.

Erase Blu-ray Storage

If you choose **OK** to erase Blu-ray storage, all bookmarks and BD-Live content saved in memory are deleted.

Update Via Network

This option displays the required storage space if the BD player is connected to internet for upgrade.

Restore factory defaults

If you choose **OK** in the prompt message box, all settings will be restored to the factory defaults.

Network Setting

1. In the main menu of **Settings**, press **▶** button, then use **▲** or **▼** button to select **Network**.
2. Press **▶** button.

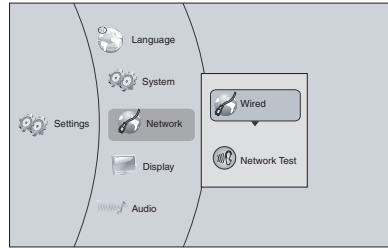

3. Press **▲** or **▼** button to select **Wired**, then press **OK** button. The IP Settings screen appears. If the network connection is active, **Link Up** appears next to **Link Status**. If the network connection is not active, **Link Down** displays next to **Link Status**.

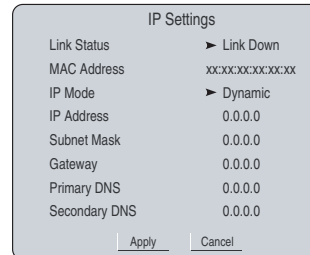

4. Press **▲** or **▼** button to select **IP Mode**, then press **OK** button.
5. Press **▲** or **▼** button to select an IP Mode. You can select:
 - **Dynamic** — Uses DHCP to automatically obtain an IP address.
 - **Manual** — Lets you manually configure network settings, such as IP address, subnet mask, and gateway settings.
 - **Off** — Disables the network interface.





The Setup Menu

6. Press ◀ or **EXIT** button to go to the previous menu.

Network Test

You can test the connectivity of the network configuration by “pinging” an IP address. Pinging means sending a signal to an IP address and waiting for a retuning signal.

AUX/OPTICAL

TV, VCR, SAT/Cable Box or portable audio players can be connected to AUDIO IN jacks at the back of the unit so that sound from the auxiliary component comes into the unit and out through the speakers.

Connecting Auxiliary Components

Refer to **Connecting AUDIO IN from external sources** such as TV for details on connecting the auxiliary components to the unit.

Selecting AUX/OPTICAL Mode

Press either **SOURCE** button on the main unit or **AUX/OPTICAL** button on the remote control to select AUX/OPTICAL mode.

Sound Output in AUX or OPTICAL Mode

- You may change the Surround Sound setting to STEREO mode if you like (see instructions under **Overview of Controls**). However, we recommend you leave the system in full surround mode.
- If the auxiliary audio signal is mono, there will be no output from some speakers in full surround mode.





Radio

The unit has a built-in tuner that allows for FM radio function. The AM loop antenna allows for AM radio function.

Manual tuning

1. Connect the FM antenna and the AM loop antenna at the back of the unit.
2. Press **TUNER** button.
3. Tune a station by pressing **TUNE** \ominus/\oplus buttons repeatedly until the desired station is found. Alternatively, you can press and hold the same buttons down for about two seconds to activate the automatic search function. In this mode the unit will automatically tune frequencies until it finds a station.
4. Repeat step 3 to tune to another radio station.
5. Press **TUNER** button to toggle between FM and AM.

Storing radio stations

The unit can store up to 30AM/30FM radio stations in its memory. You can enter every single radio station yourself or the unit can store all available radio stations automatically in ascending order.

Automatic preset programming

1. Press **TUNER** button to enter the Tuner mode.
2. Press and hold **TUNER** button for two seconds to start automatic preset programming.
3. Radio frequencies will be scanned and stored automatically. When all the available radio stations are stored or all 30AM/30FM memory locations are full, the auto preset programming function will stop.

Manual preset

1. Tune to a radio station (see **Manual tuning** for details).
2. Press **MEM/ANGLE** button. While the Program Preset number is still flashing, input your desired preset number using the numeric buttons, then press **MEM/ANGLE** button to store it.

Retrieving preset stations

1. Press **TUNER** button to enter the Tuner mode.
2. Press **◀/▶** buttons to search up or down for the preset stations or directly press the numeric buttons.



Tips:

- When the FM station broadcasts Stereo sound is found, **ST** is displayed.
- When you manually tune into a weak FM station, press **AUDIO** button on remote control to switch from **Stereo** to **Mono** mode. This will reduce the background noise.
- If there is any interference, change the antenna's position until ideal sound reception is obtained. TV and other electronic devices could be the cause of interference, so try to position the antenna away from them.
- A weak signal can affect the **Automatic preset programming** function's efficiency. Adjust the antenna for better reception and a more efficient search.





Troubleshooting

The unit does not switch on.

- Make sure it is plugged in.
- Press **STANDBY/ON** button on the remote control or **ON/STANDBY** button on the front of the unit.

The device switches off spontaneously.

- The device switches off automatically when it is in STOP mode for more than 30 minutes without any user intervention. Switch it on again.
- It might be impossible to read the disc.
- Insert the disc with the printed side facing up.
- Check that the disc can actually be played by this device.
- Clean the disc.

Blu-ray Disc or DVD does not play

- Make sure that the disc has the correct region code.
- Some Blu-ray discs will only play over an HDMI connection.

Picture-in-Picture (PiP) does not work on a Blu-ray Disc

- Make sure that the disc supports PiP mode.

When playing a BD-Live disc, the screen is black

- Erase BD Storage.
- Make sure that the internet connection is working.
- Make sure that the internet cable is connected securely and correctly to the unit and the internet jack. Some discs require an Internet connection to play.

Cannot connect to the internet

- Make sure that the Internet connection is set up correctly.
- Test the Internet connection to make sure that it is working.
- Make sure that the BD-Live Internet Access option is not set to Prohibit Access.
- Make sure that the disc you are playing is a legal copy.

After connecting to the Internet, cannot download a file

- Erase BD Storage.
- Make sure that the internet connection is working.
- Try a different USB flash drive.

File was downloaded, but playback from file pauses

- Make sure that the USB flash drive is a USB 2.0 device. Using a USB 1.1 device may cause pausing.
- Try a different USB flash drive.

There is no picture.

- Check that the TV is operating correctly.
- Check the connections.
- Select the AV input assigned to the unit on the TV.
- Replace the HDMI cable with a better one. A bad HDMI cable can cause loss of video.

The picture is of poor quality (with snow or lines).

- Check the connections.

There is no sound or the sound is of poor quality.

- Check the connections.
- Make sure the speakers are connected.
- Make sure the MUTE function is not on.

No surround sound.

- Check to see if system is actually in full Surround mode. To do this, press the **SURROUND** button on the remote control - the front panel display should indicate the current setting. If current setting is **STEREO**, the surround speakers and center speaker will be inactive. Press **▲** / **▼** button to change surround mode accordingly instead of **STEREO**.

Note: Different file/disc can have different audio type. Press **SURROUND** button on remote control follow by **▲** or **▼** buttons can select the among available surround modes with showing on front display.





Troubleshooting

I can't find my file in the JPEG listing.

- Make sure the file name is valid.

The remote control does not work or works only intermittently.

- Check that batteries are inserted or change them.
- Aim the remote control at the unit. The infrared beam must not be blocked or interrupted.
- Check that the remote control is configured to control the device you are trying to operate with it.

The subtitles do not appear.

- Check that the BD/DVD disc provides subtitles.
- Refer to the section on how to display subtitles.

The disc menu language is not the correct one.

- The disc menu language has not been set up.
- The language of your choice is not available on the disc.

Additional Information

Precautions

Use

- If your unit has been stored in a cool place for any length of time, during a journey for example, wait for about 2 hours before using it.
- The openings located on the top and bottom are for ventilation and must not be obstructed.
- During thunderstorms, we recommend that you isolate the unit from the electrical supply so that it is not damaged by electrical or electromagnetic surges.
- This unit is designed for continuous use. Switching off the unit to standby mode does not disconnect it from the mains supply. To completely isolate the equipment, remove the plug from the mains jack as some components remain connected to the electrical supply.
- If you notice any burning or smoke, disconnect the unit immediately to avoid any risk of electrocution.
- Do not attempt to look inside the unit through the disk tray opening or any other opening. You may be electrocuted or exposed to laser radiation.
- This unit is for domestic use only and must not be used for industrial purposes.
- Total or partial copying of recordings protected by copyright legislation, without the explicit permission of the holder of the rights, contravenes current legislation. Copying or downloading music files for sale or any other business purpose constitutes or could constitute a violation of copyright law.

Cleaning

- Use a soft, dry, clean cloth. Regularly dust the vents at the back or sides.
- Using solvents, abrasive or alcohol-based products risks damaging the unit.
- If an object or liquid enters inside the unit, unplug it immediately and have it checked by an authorized servicer or service center.





Additional Information

Handling and Caring for Discs

- Handle your discs with care. Hold the disc with your fingers at the edges or through the hole.
- Insert the disc with the label facing up (for a single-sided disc).
- Place the disc properly into the tray in the allotted holder.
- Use a soft cloth to clean discs if necessary, always wiping from the centre to the edge.
- Always put discs back in their cases after use and store in a vertical position.
- Do not close the tray with two discs in it or with a disc not sitting correctly in the holder.
- Do not play cracked, chipped or warped discs nor try to repair them with adhesive tape or glue.
- Do not write on a disc.
- Do not move the unit when a disc is being played.
- Do not scratch discs or store them in places exposed to direct sunlight, high humidity or high temperatures.
- Do not use aerosol cleaners, benzene, anti-static liquids or any other solvent for cleaning discs. When cleaning, wipe gently with a soft damp (water only) cloth from the centre to the edge, avoiding circular motions, which could cause scratches and interference during playback.

Compatible Formats

In order to ensure playback, discs must conform with BD, DVD or CD standards. This unit may not play some recordings or files due to differences in recording formats, software used and disc types.

BD-ROM

BD-ROMs (Blu-ray Disc Read-Only Memory) are commercially produced discs and are available in the same capacities as BD below. Other than conventional movie and video contents, these discs have enhanced features such as interactive content, menu operations using pop-up menus (see below), selection of subtitle display, and slideshow. Although a BD-ROM may contain any form of data, most BD ROM discs will contain movies in High Definition format, for playback on Blu-ray Disc players.

Blu-ray Disc (BD)

A disc format developed for recording/playing high-definition (HD) video (for HDTV, etc.), and for storing large amounts of data. A single layer Blu-ray Disc holds up to 25 GB, and a dual-layer Blu-ray Disc holds up to 50 GB of data.

DVD-Video

Digital video discs - 12 cm, single or double sided, single or dual layer. DVDs are high density optical discs on which high quality picture and audio are recorded by means of digital signals.

DVD-R, DVD-RW, DVD+R, DVD+RW

Most DVD-R and DVD+R (one recording only), DVD-RW and DVD+RW discs (rewritable), depending on the DVD writer and discs used. Recordings using DVD-R and DVD-RW discs must be made in Video DVD mode. Recordings using DVD+RW discs must be made in accordance with the specifications for DVD+RW discs with a 4.7 GB capacity.



Audio CDs

Audio CDs (12 cm).

CD-R, CD-RW

Most CD-R (one recording only) and CD-RW discs (rewritable).

CD-Rs written during a multisession recording can be played, provided that the session has ended before the disc is played (depending on the write software).

However, depending on the condition of the CD-writer, computer and the disc used, you may find that not all discs will play. When playing a CD-R disc, it is normal for the unit to take up to 60 seconds to recognize the disc before starting to play.





Additional Information

If the disc is not recognized after a period of 120 seconds, remove the disc, and insert it again.

- Do not use its full capacity.
- CD-Rs should be preferably used instead of CD-RWs (rewritable CDs) as, in certain cases, CD-RW playback may be faulty.
- Use reliable, good-quality CD write software.
- Close all other applications on the computer to ensure reliable CD-R disc recording.

JPEG Files

CD-R and CD-RW with JPEG files. Certain JPEG files, including progressive JPEG files, cannot be read by this unit.

The total number of files and folders on the disc should be less than 650. Make sure that files have the ".jpg" extension. Files without the ".jpg" extension will not be able to be read by the unit --- even though the files are shown as JPEG images on your computer.

"Blu-ray Disc" and  are trademarks.



"BD-Live" and "BD-Live" logo are trademarks of Blu-ray Disc Association.



Manufactured under license from Dolby Laboratories. Dolby and the double-D symbol are trademarks of

Dolby Laboratories.



Manufactured under license from Dolby Laboratories. Dolby, Pro Logic, and the double-D symbol are trademarks of Dolby Laboratories.



Manufactured under license under U.S. Patent #s: 5,451,942; 5,956,674;

5,974,380; 5,978,762; 6,487,535 & other U.S. and worldwide patents issued & pending. DTS and the Symbol are registered trademarks & the DTS logos are trademarks of DTS, Inc. © DTS, Inc. All Rights Reserved.



HDMI, the HDMI logo and High-Definition Multimedia Interface are trademarks or registered trademarks of HDMI Licensing LLC.



Java and logo are trademarks or registered trademarks of Sun Microsystems, Inc. in the United States and/or other countries.





Additional Information

Specifications:

Amplifier Section:

RMS Output Power: Dolby Digital Mode with 10% Total Harmonic Distortion

Front, Rear and Center Channel: 167 Watts per channel (1kHz, 8Ω)

Subwoofer Channel: 167 Watts (100Hz, 8Ω)

Total RMS Output Power, Dolby Digital mode: 1000 W

Muting Attenuation: 65 dB

Frequency Response: 200Hz /3dB, 1KHz ref.

Subwoofer Frequency Response: 10Hz/-3dB, 80Hz ref.

Signal to Noise Ratio: 65 dB (Dolby Digital mode)

AM Tuner Section:

Frequency Response: 2kHz +/-6dB, 1kHz ref.

Usable Sensitivity: 800uV/m @ S/N 20dB

Signal to Noise: 38dB

IF Rejection: 35dB

FM Tuner Section:

Frequency Response: 15kHz +/-3dB, 1kHz ref.

Quieting: 24dBu

Signal to Noise: 60dB(stereo) / 65dB(mono)

IF Rejection: 50dB

Dimensions (H x W x D mm):

Unit: 67 x 430 x 335

Front and Surround Speakers: 180 x 105 x 101

Center Speaker: 105 x 180 x 101

Subwoofer: 370 x 180 x 330





Limited Warranty

AVC MULTIMEDIA (“AVC”) makes the following limited warranty. This limited warranty extend to the original consumer purchaser and is limited to non-commercial use of the product.

One Year Parts & Labor Warranty

AVC products purchased in the United States or Canada are warranted to be free from defects in materials or workmanship for a period of one year from the date of their original retail purchase. If the unit fails to conform to this warranty, we will service the product using new or refurbished parts and products, at **AVC**'s sole discretion.

During a period of one year from the effective warranty date, **AVC** will provide, when needed, service labor to repair a manufacturing defect at its designated Service Center. To obtain warranty service in the United States or Canada, you must first call our **Customer Support Center at 1-877-252-6873, during the hours listed in the box below.** The determination of service will be made by **AVC** Customer Support. **PLEASE DO NOT RETURN YOUR UNIT TO AVC WITHOUT PRIOR AUTHORIZATION.** New or remanufactured replacements for defective parts or products will be used for repairs by **AVC** at its designated Service Center for one year from the effective warranty date. Such replacement parts or products are warranted for an additional one year from the date of repair or replacement. The Customer will be required to ship the unit to the Service Center indicated at the time Customer Support is contacted to make the necessary repairs. The customer is responsible for all transportation charges to the service facility.

Packaging and Shipping Instruction

When you send the product to the **AVC** service facility you must use the original carton box and packing material or an equivalent as designated by **AVC**.

Your Responsibility

- (1) You must retain the original sale receipt to provide proof of purchase.
- (2) These warranties are effective only if the product is purchased and operated in the United States or Canada.
- (3) Warranties extend only to defects in material or workmanship, and do not extend to any product or parts which have been lost or discarded, or damage to product or parts caused by misuse, accident, improper operation or maintenance, or use in violation of instructions provided with the product, or to product which has been altered or modified without authorization of **AVC**, or to products or parts thereof which have had the serial number removed or changed.



Limited Warranty

Out of Warranty

In the event your product requires repair after the limited warranty period has expired, please contact our Customer Support Center at **1-877-252-6873** or **www.RCAav.com**

Hours: Monday–Thursday: 9am–7pm, Friday: 9am–5pm, Saturday: 9am–NOON Eastern time.

Important:
You are responsible for any transportation, shipping or insurance relative to the return of product to our Product Returns Center.

All warranties implied by state law, including the implied warranties of merchantability and fitness for a particular purpose, are expressly limited to the duration of the limited warranties set forth above. With the exception of any warranties implied by state law as hereby limited, the foregoing warranty is exclusive and in lieu of all other warranties, guarantees, agreements and similar obligations of manufacturer or seller with respect to the repair or replacement of any parts. In no event shall AVC be liable for consequential or incidental damages.

No person, agent, distributor, dealer or company is authorized to change, modify or extend the terms of these warranties in any manner whatsoever. The time within action must be commenced to enforce any obligation of AVC arising under the warranty or under any statute, or law of the United States or Canada or any state thereof, is hereby limited to one year from the date of purchase. This limitation does not apply to implied warranties arising under state law.

This warranty gives you specific legal rights and you may also have other rights, which may vary, from state to state. Some states do not allow limitation on how long an implied warranty lasts, when an action may be brought, or the exclusion or limitation of incidental or consequential damages, so the above provisions may not apply to you.

For more information on other products and services, please visit our web site at

www.RCAav.com

Important: Also keep your "Bill of Sale" as proof of purchase.

Model no. Product name

Type of set

Serial no. Invoice no.

Date purchased Dealer name

FOR SERVICE AND REPAIR, PLEASE VISIT **www.RCAav.com**

Specifications and external appearance are subject to change without notice.

© 2009 AVC MULTIMEDIA





Printed in China
811-110091W010

